

TM9-2320-273-24P

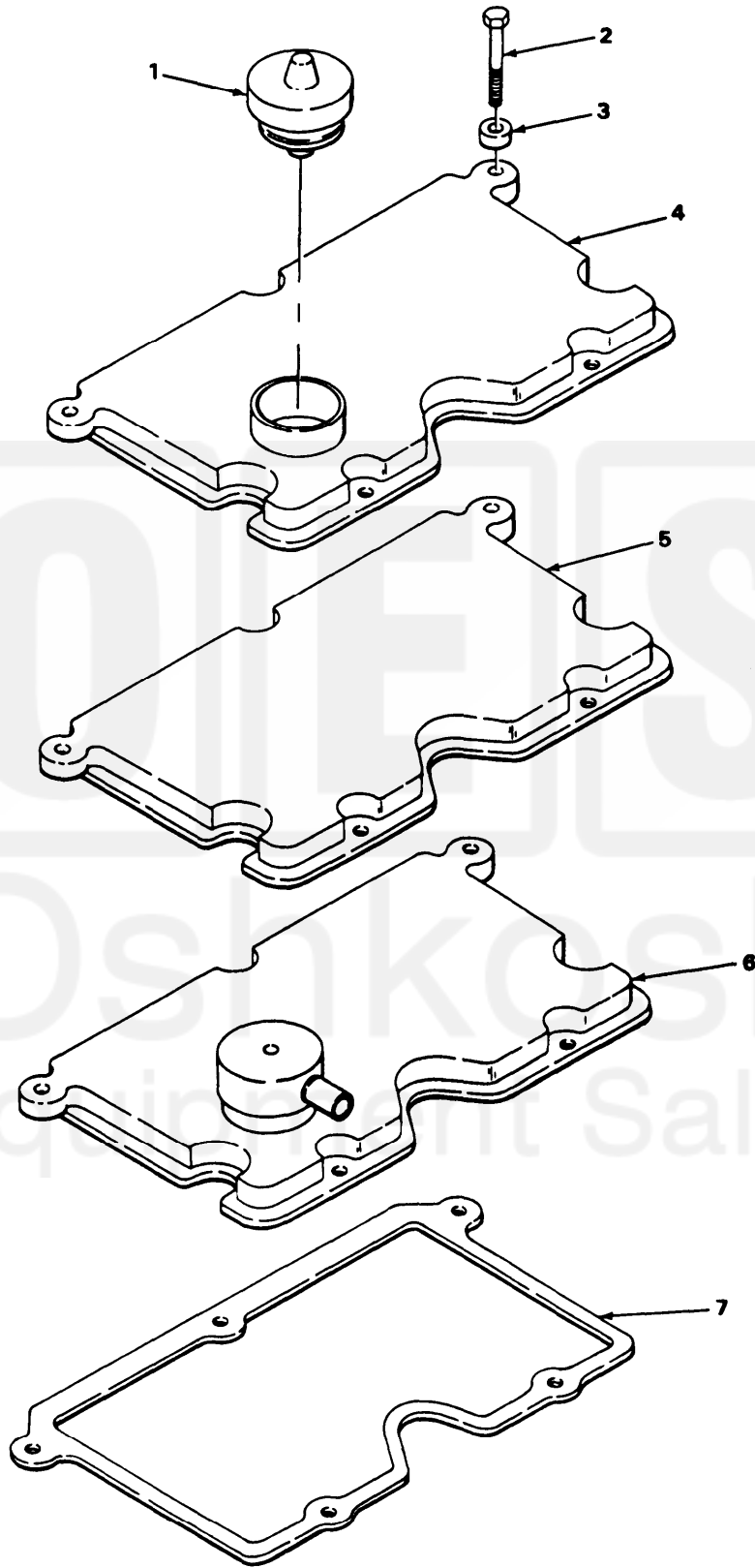

FIGURE 3. ROCKER COVERS.

Current part is item (6) on diagram. Available at www.oshkoshequipment.com

SECTION II		TM9-2320-273-24P			
(1)	(2)	(3)	(4)	(5)	(6)
ITEM	SMR		PART		
NO	CODE	FSCM	NUMBER	DESCRIPTION AND USABLE ON CODE (UOC)	QTY
				GROUP:0105 VALVES, CAMSHAFTS AND TIMING SYSTEM	
				FIGURE 3. ROCKER COVERS.	
1	PAOZZ	15434	101322	CAP, FILLER OPENING	1
2	PBOZZ	15434	3006182	SCREW, CAP, HEXAGON	15
3	PBOZZ	15434	64709	SPACER, SLEEVE	15
4	PBOZZ	15434	3006349	COVER, ENGINE POPPE	1
5	PAOZZ	15434	3006183	COVER, ENGINE POPPE	1
6	PAOZZ	15434	300658	COVER, ENGINE POPPE	1
7	PAOZZ	73165	B 90429	GASKET	3

END OF FIGURE



Current part is item (6) on diagram. Available at www.oshkoshequipment.com